

Balustrading Support Brackets & Clamps

90° Toughened Glass Clamp for 12mm glass

Product Code	Description	Finish
B1PS	Support Bracket 90°	PS
B1SS	Support Bracket 90°	SS

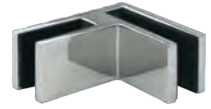
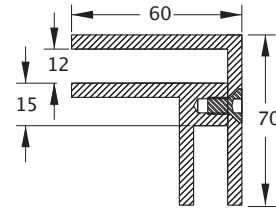
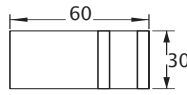

180° Toughened Glass Clamp for 12mm glass

Product Code	Description	Finish
B2PS	Support Bracket 180°	PS
B2SS	Support Bracket 180°	SS

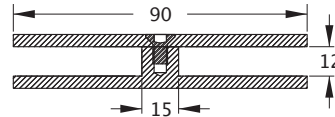

Wall to Glass Toughened Glass Clamp for 12mm glass

Product Code	Description	Finish
B3PS	Support Bracket Wall-fix	PS
B3SS	Support Bracket Wall-fix	SS

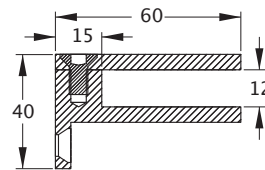
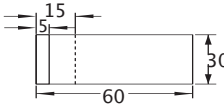

90° Laminated Glass Clamps

Product Code	Description	Finish
B10PS	Support Bracket 90° 12-15mm glass	PS
B10SS	Support Bracket 90° 12-15mm glass	SS
B20PS	Support Bracket 90° 16.76 to 21.52mm glass	PS
B20SS	Support Bracket 90° 16.76 to 21.52mm glass	SS

Note: Includes metal pressure plates & gaskets Duplex 2205. No holes in glass reqd

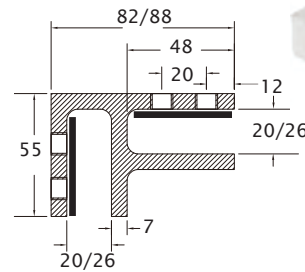
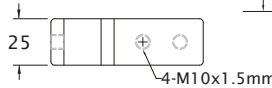

180° Laminated Glass Clamp

Product Code	Description	Finish
B12PS	Support Bracket 180° 12-15mm glass	PS
B12SS	Support Bracket 180° 12-15mm glass	SS
B22PS	Support Bracket 180° 16.76 to 21.52mm glass	PS
B22SS	Support Bracket 180° 16.76 to 21.52mm glass	SS

Note: Includes metal pressure plates & gaskets Duplex 2205. No holes in glass reqd

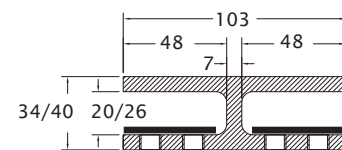
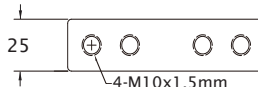

Wall to Glass Laminated Glass Clamp

Product Code	Description	Finish
B13PS	Support Bracket Wall-fix 12-15mm glass	PS
B13SS	Support Bracket Wall-fix 12.15mm glass	SS
B23PS	Support Bracket Wall-fix 16.76 to 21.52mm glass	PS
B23SS	Support Bracket Wall-fix 16-76 to 21.52mm glass	SS

Note: Includes metal pressure plates & gaskets. Duplex 2205. No holes reqd

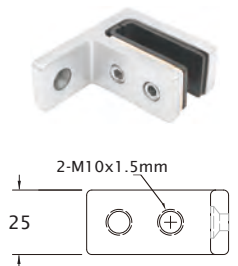
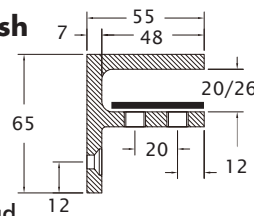

Adjustable Angle Clamp

Product Code	Description	Finish
B14PS	Glass to Glass	PS
B14SS	Glass to Glass	SS

Suits 12-15mm glass. 27mm gap between glass panels

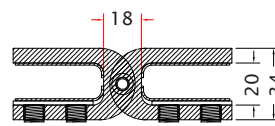
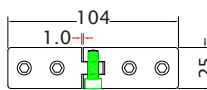

Vetro Raccordi

Balustrading Support Brackets & Clamps

Balustrading Support Bracket, Wall to Glass

Product Code	Description	Finish
B7PS	Wall to Glass	PS
B7SS	Wall to Glass	SS

Suits up to 15mm glass

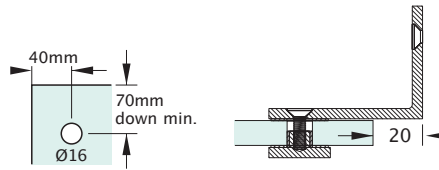

Balustrading Support Bracket, Glass to Glass 90°

Product Code	Description	Finish
B6PS	Glass to Glass	PS
B6SS	Glass to Glass	SS

Suits up to 15mm glass. Same hole dimension on both panels

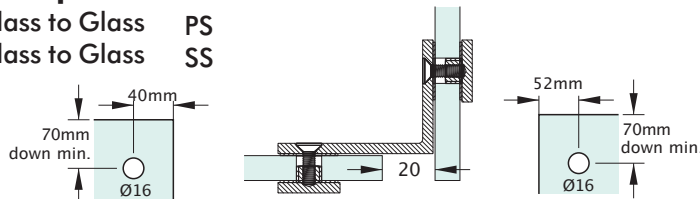

Round Clamp

Product Code	Description	Finish
NVC2PS	Round design, Square Post	PS
NVC2SS	Round design, Square Post	SS

Note

- 8mm - 12mm Glass
- 316 Stainless

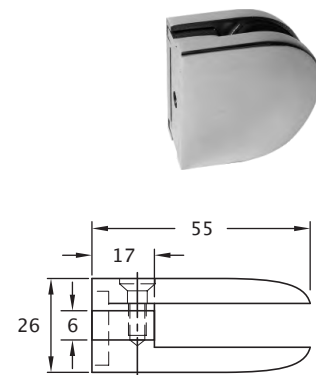
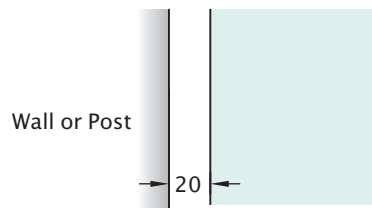

Square Clamp

Product Code	Description	Finish
NVC4PS	Square design, Square Post	PS
NVC4SS	Square design, Square Post	SS

Note

- 8mm - 12mm Glass
- 316 Stainless

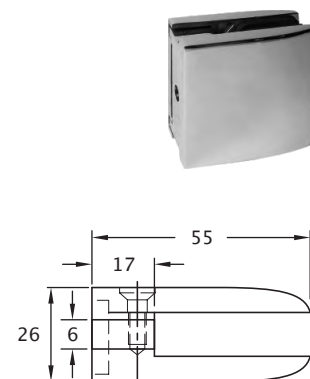
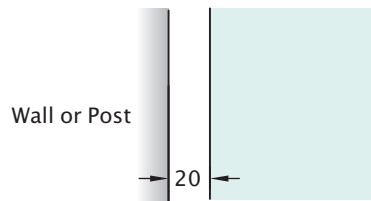

Adaptor Plate

Product Code	Description	Finish
NVCRPS	Round Post Adaptor Plate	PS
NVCRSS	Round Post Adaptor Plate	SS

Note

- Plate for use with Clamps for fixing to round post

